

This document is exclusive MARECO LUCE s.r.l., is strictly prohibited disclosure or reproduction, even partial, as well the use of without written consent of MARECO LUCE s.r.l..The company reserves the right to change models, dimensions and materials at any time without notice.

PRODUCT DATA SHEET

Barcelona Led

Code : 1604484N

PRODUCT FAMILY

- Urban architectural LED luminaire, suitable for uplight installation on poles Ø60mm on top (IP65)

MATERIAL CHARACTERISTICS

- Hexagonally shaped base made of die-cast aluminium (ADC12) anodized and painted
- Diffuser in thick (3.5mm) transparent PMMA (acrylic), hexagonally shaped at base (connection to aluminium base) and circular at the top (connection to cover)
- Circular shaped top cover in NY-FV30% moulded with "micro-shot blasted" finish
- Cone covering gear tray in black, NY-FV30%
- Heat sink frame for in solid, anodised aluminium
- Polyester powder coating with a pretreatment (Phosphochromating method) to ensure high protection against weathering
- Silicone gaskets
- A2 stainless steel screws

COLOUR

- Black textured

LIGHTING CHARACTERISTICS

- LED's lighting source in fixed position
- Immediately ON at 100% of the light flux
- Monochromatic LED module (12 Led's - 28.2W)
- Monochromatic LED module (24 Led's - 40.1W - 54.6W)
- Led's SeoulZ5M2
- Round symmetrical light throw
- Lenses in highly transmittant PMMA (93% efficiency) with unilateral opening of light beam allowing for good spacing between luminaire
- One lens for each group of 3 LED's is fitted with a more diffused lens to guarantee uniformity of the light flux, especially directly below the luminaire
- LED's covers arranged in a ring formation, made from NY/FV30% matte white colour, snaps into place without screws LED optics for a round symmetrical, predominantly frontal light throw, guaranteeing a good level of performance at elevated distances

WIRING CHARACTERISTICS 28.2W - 12 Led's

- n°4 monochromatic LED's module with n°3 Led's SeoulZ5M2
- Built-in driver (700mA driver output)
- Surge protection kit - SPD:
- Max impulse voltage UOC 10KV
- Voltage protection level L-N <1500V

WIRING CHARACTERISTICS 40.1W - 24 Led's

- n°8 monochromatic LED's module with n°3 Led's SeoulZ5M2
- Built-in driver (500mA driver output)
- Surge protection kit - SPD:
- Max impulse voltage UOC 10KV
- Voltage protection level L-N <1500V
- Voltage protection level L-PE <1500V

WIRING CHARACTERISTICS 54.6W - 24 Led's

- n°8 monochromatic LED's module with n°3 Led's SeoulZ5M2
- Built-in driver (700mA driver output)
- Surge protection kit - SPD:
- Max impulse voltage UOC 10KV
- Voltage protection level L-N <1500V
- Voltage protection level L-PE <1500V

- The modules are connected in parallel via a quick release connector, fixed to the thick circular

anodised aluminium heat sink through n.2 screws

- Heat sink frame for LED's in thick anodised aluminium connected to cover with thermo-conducting silicone grease
- Heat sink frame/LED's modules are easily replaced because of polarised connector
- Easily extractable gear tray made from NY-FV30% connected to terminal with automatic connection
- In the case of malfunction, one LED module malfunctions, however the other modules remains functional keeping the light fitting on

INSTALLATION AND ORDINARY MAINTENANCE CHARACTERISTICS

- Luminaire for direct installation on pole tops Ø60mm
- Pre-wired with H05RN-F 2x1.5mmq cable (50cm) for the connection to the mains - 28.2W
- Pre-wired with H05RN-F 3x1.5mmq cable (50cm) for the connection to the mains - 40.1W - 54.6W
- Fixing to pole using n.3 screws, n.1 of which is a through bolt (safety)
- Ordinary maintenance by loosening n.1 screw placed at the top of the cover in order to access the optical compartment

DIMENSIONS

- Conically shaped fixture with hexagonal-circular sections
- Ø515x505mm

TECHNICAL SPECS

- LED's type: SeoulZ5M2
- Step MacAdam: 3
- Lifetime Led's: L80/B50 - 100Kh Tc 85°C
- Lifetime driver: 50Kh
- Power factor: 0.97
- Warranty: 3 years

TECHNICAL SPECS 4000K - 28.2W

- LED's output: 3252lm@tc25°C
- Luminaire output: 2254lm@ta25°C
- LED's efficiency: 129lm/W
- Luminaire efficiency: 79lm/W
- LED's consumption: 25.2W
- Luminaire consumption: 28.2W
- Insulation class: II
- RG: 2 <40cm

TECHNICAL SPECS 3000K - 28.2W

- LED's output: 3192lm@tc25°C
- Luminaire output: 2217lm@ta25°C
- LED's efficiency: 127lm/W
- Luminaire efficiency: 78lm/W
- LED's consumption: 25.2W
- Luminaire consumption: 28.2W
- Insulation class: II
- RG: 2 <50cm

TECHNICAL SPECS 4000K - 40.1W

- LED's output: 4896lm@tc25°C
- Luminaire output: 3074lm@ta25°C
- LED's efficiency: 136lm/W
- Luminaire efficiency: 76lm/W

- LED's consumption: 36W
- Luminaire consumption: 40.1W
- Insulation class: I
- RG: 2 <45cm

TECHNICAL SPECS 3000K - 40.1W

- LED's output: 4800lm@tc25°C
- Luminaire output: 3024lm@ta25°C
- LED's efficiency: 133lm/W
- Luminaire efficiency: 75lm/W
- LED's consumption: 36W
- Luminaire consumption: 40.1W
- Insulation class: I
- RG: 2 <55cm

TECHNICAL SPECS 4000K - 54.6W

- LED's output: 6505lm@tc25°C
- Luminaire output: 4099lm@ta25°C
- LED's efficiency: 129lm/W
- Luminaire efficiency: 73lm/W
- LED's consumption: 50.4W
- Luminaire consumption: 54.6W
- Insulation class: I
- RG: 2 <55cm

TECHNICAL SPECS 3000K - 54.6W

- LED's output: 6384lm@tc25°C
- Luminaire output: 4031lm@ta25°C
- LED's efficiency: 127lm/W
- Luminaire efficiency: 72lm/W
- LED's consumption: 50.4W
- Luminaire consumption: 54.6W
- Insulation class: I
- RG: 2 <65cm

Rev 04 - 30/07/2021

Details

- Conformity with CEE directives
- CLASS I
- Double insulation/class II
- IK08
- RG1
- CRI>80
- CLASS A+
- IP 65

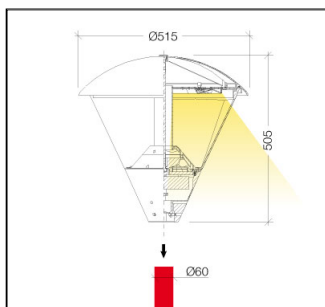

220-240V 50/60Hz 54,6W							
CE	⊕	□	IK 08	RG	CRI >80	A+	IP65

