

This document is exclusive MARECO LUCE s.r.l., is strictly prohibited disclosure or reproduction, even partial, as well the use of without written consent of MARECO LUCE s.r.l. The company reserves the right to change models, dimensions and materials at any time without notice.

PRODUCT DATA SHEET

Challenge basic wall fixing

Code : 1575184N

PRODUCT FAMILY

- Urban architectural LED (IP65) complete with wall mounting bracket

MATERIAL CHARACTERISTICS

- Extruded aluminium housing EN AW 6026, manufactured with numerical control machines and then anodized
- Black moulded in NY-FV30% covering carter/housing
- 2mm thick hot-dip galvanized steel brackets 75µm UNI EN 1461
- Polyester powder coating with a pretreatment (Phosphochromating method) to ensure high protection against weathering
- Silicone transparent optics
- Silicone gaskets
- A2 stainless steel screws

COLOUR

- Black textured

LIGHTING CHARACTERISTICS

- The light source can be tilted $\pm 30^\circ$
- CUT-OFF luminaire conforming to all regional/local laws against light pollution
- Asymmetric optics: light flux projected with a "bat-wing" distribution, with opening of the light beam. Suitable for correct lighting of main and secondary roads
- Immediately ON at 100% of the light flux
- Luminaire conforms with local and international dark sky laws with emission 0.49cd/Klm for angles 90° , Rn 0.04% - 67.09%
- Visual LEDIL lenses in transparent optical grade silicon with precise light control and high efficiency

WIRING CHARACTERISTICS

- Led's Philips Fortimo SLM 1211G7
- Driver included
- Equipped with osmotic valve for leakage of air and humidity

INSTALLATION AND ORDINARY MAINTENANCE CHARACTERISTICS

- Luminaire for wall-mounting installation
- Pre-wired with H07RN-F 2x1.5mmq cable (100cm) for the connection to the mains
- M20x1.5mm cable gland
- Ordinary maintenance (not necessary)
- Extraordinary maintenance by untightening 4 screws to access the wiring compartment in the reinforced thermoplastic carter

DIMENSIONS

- 311x128x63mm

OPTIONAL ACCESSORY (TO BE ORDERED SEPARATELY):

- Cod. CS160033 Surge protection kit
- When purchased the protection kit will be installed inside the luminaire
- Max impulse voltage UOC 10KV
- Voltage protection level L-N <1500V

TECHNICAL SPECS

- LED's type: Philips Fortimo SLM 1211G7
- Step MacAdam: 3
- Lifetime Led's: L80/B10 - 50Kh Tc 65°C
- Lifetime driver: 50Kh
- Power factor: 0.96
- Warranty: 3 years

TECHNICAL SPECS 4000K - 26.2W

- LED's output: 4465lm@tc25°C
- Luminaire output: 3694lm@ta25°C
- LED's efficiency: 192lm/W
- Luminaire efficiency: 141lm/W
- LED's consumption: 23.2W
- Luminaire consumption: 26.2W

TECHNICAL SPECS 3000K - 26.2W

- LED's output: 4229lm@tc25°C
- Luminaire output: 3500lm@ta25°C
- LED's efficiency: 183lm/W
- Luminaire efficiency: 133lm/W
- LED's consumption: 23.2W
- Luminaire consumption: 26.2W

TECHNICAL SPECS 4000K - 39.3W

- LED's output: 6485lm@tc25°C
- Luminaire output: 5303lm@ta25°C
- LED's efficiency: 181lm/W
- Luminaire efficiency: 135lm/W
- LED's consumption: 35.9W
- Luminaire consumption: 39.3W

TECHNICAL SPECS 3000K - 39.3W

- LED's output: 6145lm@tc25°C
- Luminaire output: 5024lm@ta25°C
- LED's efficiency: 171lm/W
- Luminaire efficiency: 128lm/W
- LED's consumption: 35.9W
- Luminaire consumption: 39.3W

Rev 03-06/11/2019

Details

- Conformity with CEE directives
- Conforms to all regional/local laws against light pollution
- Double insulation/class II
- IK08
- RG1
- CRI>80
- CLASS A+
- IP 65



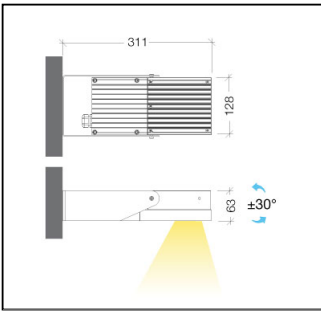

220-240V 50/60Hz 26,2W

